

SK301 | 猛龍氣動流體幫浦

AIR OPERATED FLUID PUMP

特點

- (1) 幫浦作動採油氣分離，不會污染油脂。
- (2) 典型的使用範圍為工廠、汽修廠、船舶保養、採礦機械、農耕、軍隊、建築、大眾運輸等
- (3) 低噪音，出油順暢、不會間斷。
- (4) 幫浦本體材質採用高強度鋁合金鍛造成型。

用油

- (1) 一般 00#~2# 黃油均能順暢注入。
- (2) 內附FP101壓力板，可搭配使用於較高黏度黃油或寒冷地區。

Feature

- (1) Pump moves and oil suction are two separation system, it won't contaminating grease.
- (2) Typically used in workshops, service stations, fleet maintenance, mining, agriculture, armed forces, construction, trains, etc.
- (3) Low noise, smooth greasing, no disjointed greasing.
- (4) The pump is made of aluminum alloy by forging.

Grease usage

- (1) General 00#~2# grease all can be infused into smoothly.
- (2) Included FP101 follower plate, can be used with higher viscosity grease or cold areas.

放入方式 *How to put inside*

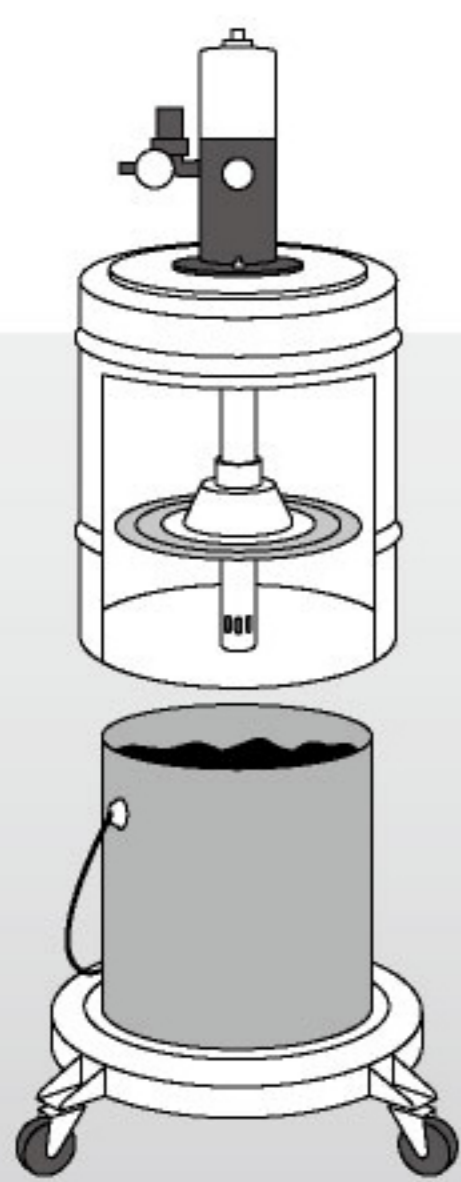

型號 Model	容量 Capacity	空氣輸入壓力 Air Input Pressure	壓力比 Pressure Ratio	黃油輸出壓力 Grease Output Pressure	輸出量 Deliver Rate	油管長度 Hose Length	淨重 N.W.	毛重 G.W.	材積 CUFT
SK301	20L	3~7 bar 40~100 psi	55 : 1	165~385 bar 2200~5500 psi	2 g/cycle	10 ft	15.0 kgs	17.5 kgs	5.5'